

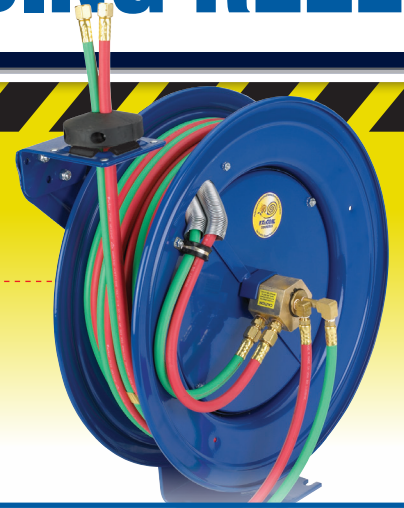

FEATURE FOCUS :: **EZ-COIL** EQUIPPED

# SPRING DRIVEN WELDING REEL

EXPLODED ASSEMBLY:

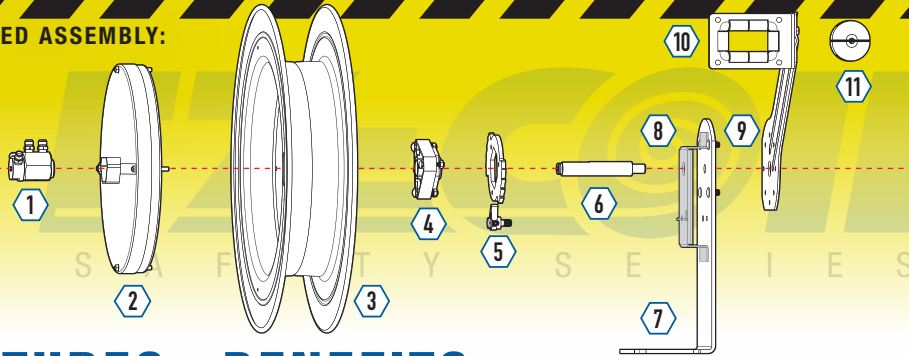

## FEATURES & BENEFITS

### STEEL CONSTRUCTION

High-Quality steel construction provides superior strength and durability for heavy-duty applications in commercial and industrial settings.

### EZ-COIL EQUIPPED

A Coxreels patented safety system that retracts up to **80% SLOWER** than conventional reels

### POWDER COAT

CPC™ Powder Coat. Long lasting, chip resistant and rust inhibiting CPC™ powder coat finish seals all steel components for maximum corrosion resistance.



#### 1 EXTERNAL FLUID PATH

External fluid path with 90° full-flow dual ported brass swivel offering both connections from the same side of the reel. The swivel screws directly on 1" solid steel axle, for simple VITON® seal maintenance and fast and easy hose installation. No need to remove the reel from its mount.  
- With swivel lock bracket ensures maximum safety.

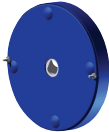

#### 2 CARTRIDGE MOTOR

Lubricated and enclosed cartridge-style spring motor is easily removable for safe and convenient maintenance. Precision coil spring factory tuned and matched to application for longest life cycle and performance.



#### 3 CNC SPUN DISCS

Heavy duty CNC robotically spun and ribbed discs with rolled edges for greater strength, durability, hose protection and operator safety.

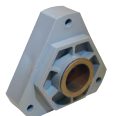

#### 4 PRECISION BEARINGS

Sturdy permanently lubricated precision bearings for smooth rotation and trouble-free operation.



#### 5 LOCKING RING

Multi-position, robust zinc plated locking ring and non-corrosive stainless steel lock ratchet mechanism to secure hose at desired length.



#### 6 SOLID STEEL AXLE

1" solid steel axle with flat arbor for strong spring engagement and stainless steel set screw for non-corrosive swivel assembly provides solid internal core, long lasting use and reliable performance. Not a hollow tube, no fluid travels through it.

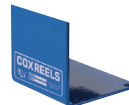

#### 7 1/4" STEEL BASE

Sturdy single pedestal design with solid one piece, heavy gauge 1/4" steel base and support post, no weld, for maximum stability.



#### MOUNTING PATTERN

Simple slotted mounting pattern located in the steel base for fast and easy reel installation and detachment.



#### 8 SUPER HUB™

Exclusive Super Hub™ dual axle support system increases the stability during operation, reduces vibration and strengthens the structural integrity of the reel.

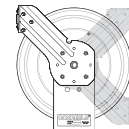
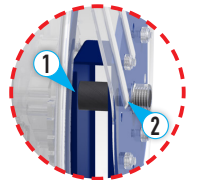

#### 9 MULTI-POSITION GUIDE ARM

Versatile steel guide arm adjusts to wall, floor, ceiling & vehicle mounting positions.



#### 10 FOUR-WAY ROLLER BRACKETS

Pinch-proof four-way rollers allow the hose to be pulled from 360° for greater directional use coverage.



#### 11 HOSE STOP

Adjustable solid rubber hose stop for convenient lead length positioning.

## ACCESSORIES & UPGRADES



MOUNTING BRACKETS

Designed for **OXY-ACETYLENE** AND "T" GRADE FUEL



[www.coxreels.com](http://www.coxreels.com)

800.COX.REEL

P: 480.820.6396

F: 480.820.5132

E: [info@coxreels.com](mailto:info@coxreels.com)

FF-EZWR-01