

# HOW TO ORDER

## SELECTING THE PROPER REEL

The size, length and type of hose to be handled are primary factors in selecting the proper reel for your job. The following points should be considered:

### 1. HOSE I.D., O.D. & LENGTH

When space permits, select a reel with greater hose capacity than you require. This allows you to rewind the hose with less care and keeps the hose well protected within the disc dimension, even if the hose is not wound in uniform coils. (See hose selection chart below)

### 2. SIZE & TYPE OF SWIVEL JOINT & SEAL FOR INLET & OUTLET

In selecting your reel please note the size of your hose versus the inlet and outlet sizes. Reducing your fitting and hose size will allow for more hose capacity. Please refer to the o-ring seal compatibility chart on page 50 for special application requirements.

### 3. RETRACTION METHOD & PROPER USE

Choose from Spring Driven, Hand Crank or Motor Driven retraction.

**SPRING DRIVEN:** Automatic rewind requiring no power source. Operator is to guide the hose or cord as it self-retracts and wraps around the drum. **For models to be mounted 15 feet above the floor, consult factory & specify on P.O.'s for proper spring retraction motor.**

**HAND CRANK:** Operator must manually crank the reel and guide the hose or cord evenly as it wraps around the drum to reach full capacity.

**MOTOR DRIVEN:** Requires a power source to operate in AC, DC, Air or Hydraulic power. On/Off switches and speed controllers are available to help control retraction speed. You must guide the hose or cord efficiently back on the reel to reach full capacity.

### 4. MOUNTING POSITION

Determine which mounting position you require. All reels are shipped in the floor-ceiling mount (FM) position with the exception of the "T," "EN," and "SD" Series, which are shipped in the wall-truck mount (WM) position. See diagram to the right for the "SP & DP" Series as well.

### 5. CHOOSE TYPE OF HOSE

Consider temperature, product type and pressure required (PSI).

Always use good quality hose rated for the service and operating pressure required. Poor quality hose tends to expand and contract under pressure surges. When this happens, hose remaining on the reel may bind and become difficult to handle. In extreme cases, poor quality hose may expand under pressure to the extent that the reel becomes distorted and inoperable.

### 6. ADDITIONAL OPTIONS

**Customize your reel to meet your exact requirements.** Once you select your reel type consider the different add-on features such as roller brackets, special mounting brackets, carry handles or a cart for portability. See the options available indicated on each page.

## BASIC INFORMATION

The Diagram Below Indicates The Basic Information Which Should Be Determined Before Ordering.

Hose I.D., O.D., & Length

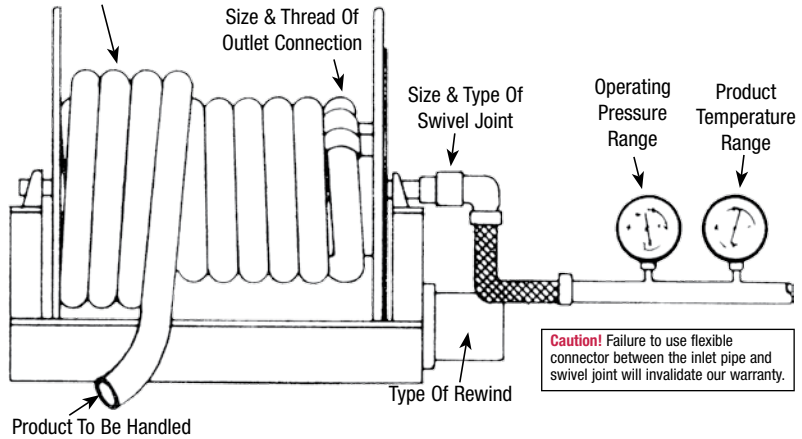

## MOUNTING POSITIONS

The Diagrams Below Indicate The Mounting Positions Which Should Be Determined Before Ordering.

**ALL MODELS** with the exception of the SP & DP Series

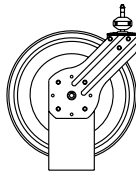

**"FM"** Floor-Ceiling Mount  
All reels are shipped in this position unless specified with the exception of the T, EN, SD, SP & DP Series

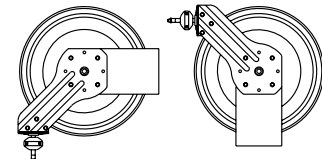
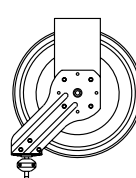

**"WM"** Wall-Truck Mount  
T, EN & SD Series are shipped in this position unless specified

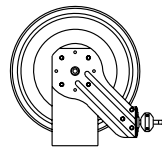

**"BM"**  
Bottom-Truck Mount

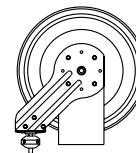

**"DM"**  
Down Mount

## E-MAIL INFORMATION

If you would like more information, feel free to e-mail us concerning your order or general questions you may have.

For general info or questions:  
[info@coxreels.com](mailto:info@coxreels.com)

For technical assistance:  
[techassist@coxreels.com](mailto:techassist@coxreels.com)

## HOSE SELECTION

The drawing below shows two reels with different shapes and dimensions but with identical hose capacity. In most cases, more than one reel will handle the size and length of hose you need, so you can specify a reel to fit your space requirements.

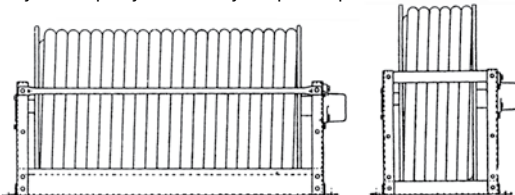

See Page 50 For Hose Assemblies & Component Parts

## SP & DP SERIES

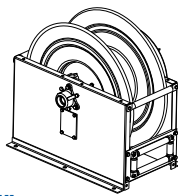

**"FM"** Floor-Ceiling Mount (Drag)  
All SP & DP Series are shipped in this position unless specified

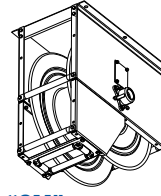

**"CM"** Ceiling Mount  
(Lift, Stretch Or Recover)

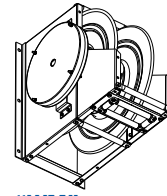

**"WM"** Wall Mount  
(Lift)

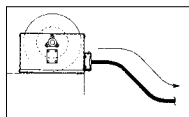

**DRAG**  
With Roller Guide

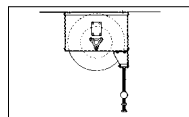

**LIFT**  
With Roller Guide

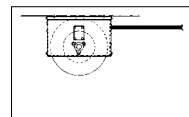

**STRETCH**  
With Or Without Roller Guide  
Special Spring Motor Required,  
Consult Factory

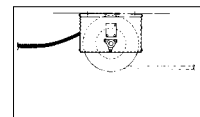

**RECOVER**  
(Pick-up) No Roller Guide Needed,  
Special Spring Motor Required,  
Consult Factory